

BABY CHANGING STATIONS



BABY CHANGING STATIONS

PROVIDING THE HIGHEST LEVEL OF SAFETY

In all businesses that count families with babies among their visitors, there is a need for a comfortable environment where infants can be nursed safely and hygienically.

Safety, strength, quality and usability make the DAN DRYER baby changing stations a popular choice when designing user-friendly, long-life baby changing areas in public and commercial businesses.

Our baby changing stations can be found in various business sectors worldwide – airports, supermarkets, shopping malls, campsites, holiday resorts, hotels, restaurants, amusements parks, cultural centres, sport arenas and on trains operating in Europe.

We have the experience and in-depth knowledge of developing and producing sanitary equipment for commercial and public toilet facilities.

Our strength lies in unique know-how and a company protocol enabling us to respond quickly and flexibly to individual requirements and specifications.



BJÖRK BABY CHANGING STATION

- Wall mounted
- 2-year warranty
- Holds up to 176.37 lb.
- Strong materials with rounded edges for optimal safety
- Torsion springs ensure smooth and easy opening and closing motion
- Available in black, white and all RAL colors
- Ideal for toilets with limited wall space
- TÜV-certified



UNIT WITH BELT
(ASTM F2285-04(2016)e1 _Diaper Changing Tables for Commercial Use)



UNIT WITHOUT BELT
(Certified by TÜV NORD Baumuster in accordance with DIN EN 12221-1:2008 + A1:2013)

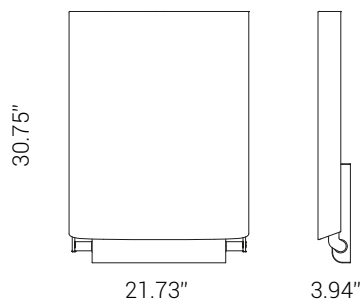

BJÖRK PAPER DISPENSER

- Wall mounted
- 2-year warranty
- Equipped with safety lock
- Holds multi-fold paper towels 13.39 x 7.99"
- Available in black, white and all RAL colors
- Practical and hygienic solution securing a clean changing surface at all times

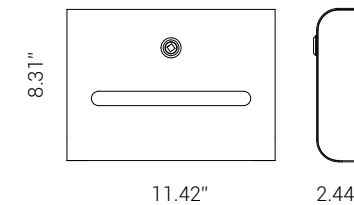

BABY CHANGING MAT

- Available in black and grey
- Hand sewn and easy to clean
- Fastened to the table with velcro
- L: 25.59 x W: 17.72 x H: 0.78"
- For DAN DRYER baby changing stations
- Coated with 100% Oeko-Tex certified PU-leather



AWARDS

BJÖRK BABY CHANGING STATION

- Red Dot Design Award, best of the best, 2017
- German Design Award, 2018
- Good Design, 2018







DAN DRYER BABY CHANGING STATION

- Wall mounted
- 2-year warranty
- Made of cleaning-friendly materials
- Unique carrying capacity of up to 881.85 lb.
- Can be combined with matching paper roll holder
- Space-saving; folds up against the wall when not in use
- Strong safety strap and rounded edges for optimal safety
- Available in white and all RAL colors

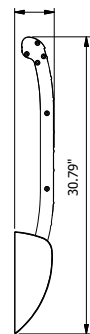
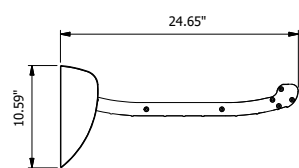
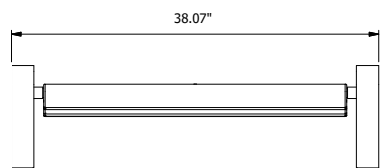
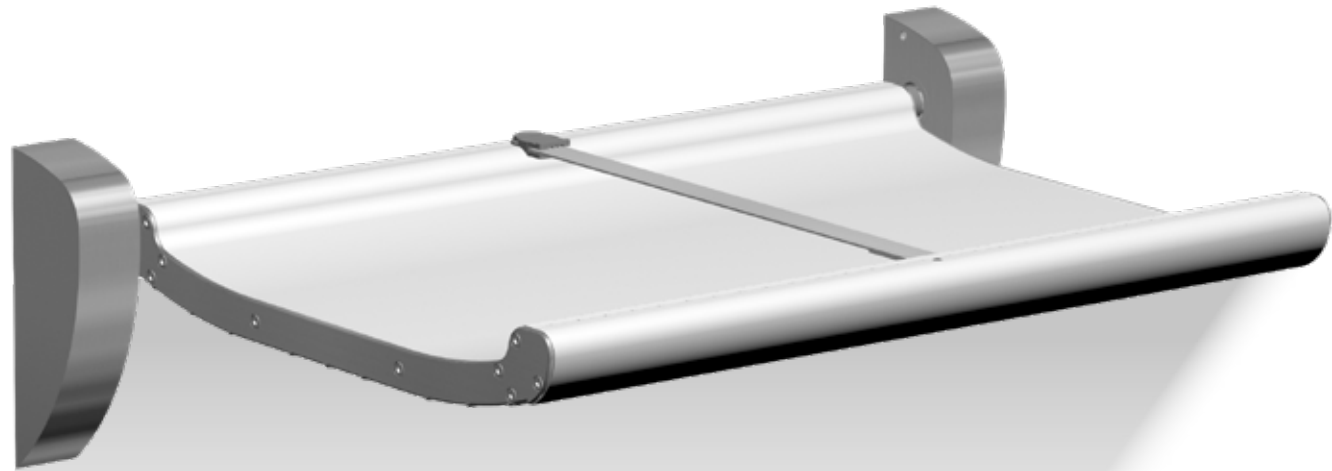

PAPER ROLL HOLDERS

- Wall mounted
- 2-year warranty
- Holds 27.56 x 3.94" paper rolls
- Very sturdy model with safety locks
- Hygienic solution securing a clean changing surface at all times
- Available in white and all RAL colors

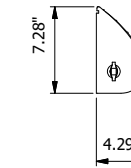
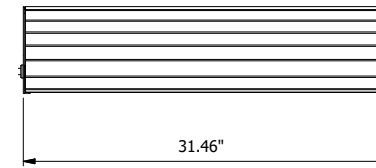

- Wall mounted
- 2-year warranty
- Holds 19.69 x Ø3.94" paper rolls
- Comes in brushed stainless steel as standard
- Solid locking system makes the holder very sturdy
- Available in stainless and all RAL colors
- Integrated gas spring enables easy one-handed paper refill
- Sight holes make it easy to check how much paper is still left

